

WILLOW

mini | user guide



UIMAGE





WITH LOVE FROM COPENHAGEN

At UIMAGE, our designers take inspiration from the distinct nature of the Nordic landscape to create unique designs related to the way we live in an urban setting. Influenced by the design language, colours and materials found around us in Scandinavia, we create a collection that is rooted in our home but designed for everyone.

Versatile, flexible and multifunctional, our furniture and accessory collection is designed for packing the most into life in smaller spaces!

ENGLISH

If the external flexible cable or cord of this luminaire is damaged, it shall be exclusively replaced by the manufacturer or his service agent or a similar qualified person in order to avoid a hazard.

Different wall materials require different types of screws. Always choose screws that are specially suited to the materials of your walls.

DEUTSCH

Falls das äußere biegsame Kabel oder das Anschlusskabel dieser Beleuchtung beschädigt wird, darf es nur vom Hersteller, dessen Servicevertreter oder einer anderen qualifizierten Kraft ausgetauscht werden, um eventuelle Risiken auszuschließen.

Unterschiedliche Wandmaterialien erfordern unterschiedliche Schrauben. Immer Schrauben verwenden,

die für die Wandbeschaffenheit geeignet sind.

FRANÇAIS

Si le câble électrique de ce luminaire est endommagé, il peut être remplacé. Pour éviter tout danger, le remplacement doit impérativement être effectué par le fabricant, un représentant de celui-ci ou un réparateur agréé.

Le choix des vis dépend du matériau dans lequel elles doivent être fixées. Utiliser des vis adaptées au matériau de votre mur.

NEDERLANDS

Als het snoer of de buitenste flexibele kabel van deze verlichting beschadigd is, mag deze uitsluitend door de fabrikant, diens service-agent of een andere vakman vervangen worden. Dit om eventuele risico's te vermijden.

Voor verschillende wandmaterialien

heb je verschillende schroeven nodig. Completeer met schroeven die geschikt zijn voor het materiaal van de wand.

DANSK

Hvis det ydre, bøjelige kabel eller ledningen til lampen beskadiges, må den kun udskiftes af producenten, dennes serviceagent eller en anden kvalificeret person for at undgå farlige situationer.

Forskellige vægmaterialer kræver forskellige typer skruer. Vælg skruer, som egner sig til det relevante vægmateriale.

ÍSLENSKA

Ef ytri sveigjanlega snúran í þessu ljósi er skemmd þarf að leita til framleiðandans, þjónustuaðila eða annars fagaðila til að skipta henni út fyrir nýja svo að hægt sé að fyrirbyggja að hætta skapist.

Veggir húsa eru úr mismunandi efnum og nota þarf mismunandi skrúfur í þá. Veljið alltaf skrúfur sem henta efnum í veggjum heimilisins.

NORSK

Om kablen eller ledningen til denne belysningen blir skadet, får den kun byttes ut av leverandøren, dennes serviceagent eller en annen kvalifisert fagmann for å unngå eventuell fare.

Ulike veggmaterialer krever ulike skruer. Suppler med skruer som passer til materialet i din vegg.

SUOMI

Jos valaisimen uloin, taipuisa kaapeli tai johto vioittuu, turvallisuuksystä sen saa vaihtaa vain valmistaja tai valtuutettu huoltoliike.

Erilaisiin seinämateriaaleihin on käytettävä erilaisia ruuveja. Valitse kotisi seinämateriaaliin sopivat ruuvit.

SVENSKA

Om den yttre böjliga kabeln eller sladden till denna belysning skadas, får den endast bytas ut av tillverkaren eller dennes serviceagent eller annan behörig person, för att undvika eventuella risker.

Olika väggmaterial kräver olika skruvar. Komplettera med skruvar som passar materialet i din vägg.

TÜRKÇE

Bu aydınlatmanın harici esnek kablosu veya kordonu zarar görürse, tehlikeden kaçınmak için üretici firma veya üretici firma yetkili servisi veya benzeri bir kişi tarafından değiştirilecektir.

Farklı duvar materyalleri farklı türde vida gerektirir. Her zaman, duvarınızın yapı malzemesine uygun vidaları seçiniz.

БЪЛГАРСКИ

Ако външният подвижен кабел на

лампата бъде повреден, той трябва да бъде подменен единствено от производителя, негов представител или друго квалифицирано лице, за да се избегнат рискове.

Различните стенни материали изискват различни видове винтове. Винаги избирайте винтове, специално съобразени с материала на вашите стени.

ΕΛΛΗΝΙΚΑ

Εάν το εξωτερικό ευέλικτο καλώδιο αυτού του φωτιστικού φθαρεί, για την αποφυγή ατυχήματος, θα πρέπει να αντικατασταθεί μόνο από τον κατασκευαστή ή το εξουσιοδοτημένο σέρβις του ή από ένα άλλο ειδικευμένο άτομο.

Για τα διαφορετικά υλικά τοίχου, απαιτούνται και διαφορετικοί τύποι βιδών. Επιλέγете πάντοτε βίδες, οι οποίες να είναι ειδικά κατάλληλες για

τα υλικά των τοίχων σας.

ČESKY

Je-li vnější přívodní kabel svítidla poškozen, musí být vyměněn pouze výrobcem, autorizovaným servisem nebo jiným kvalifikovaným odborníkem, aby nedošlo k ohrožení zdraví.

Různé typy stěn vyžadují různé druhy šroubů. Vždy použijte šrouby, které jsou vhodné do daného typu materiálu.

ESPAÑOL

Si se dañase el cable exterior flexible de esta lámpara, para evitar riesgos deberá ser sustituido exclusivamente por el fabricante, su representante o un electricista cualificado.

Diferentes materiales de pared requieren diferentes tornillos. Complete con aquellos que mejor se adapten a tu tipo de pared.

ITALIANO

Se il cavo flessibile esterno o filo elettrico di questa illuminazione è danneggiato, può essere sostituito esclusivamente dal produttore, da un centro di assistenza autorizzato o da un elettricista qualificato, per evitare rischi.

I diversi materiali delle pareti richiedono tipi diversi di viti. Scegli viti adatte al materiale della parete in questione.

MAGYAR

Ha a külső rugalmas vezeték vagy kábel megsérül, biztonsági okból csak szakember vagy a szerviz munkatársai végezhetik el a cserét.

A különböző anyagú falakhoz, különböző típusú csavarokat használj. Válassz mindig olyan csavart (és tipliket), melyek a leginkább alkalmasak a falad anyagához.

POLSKI

Jeżeli zewnętrzny przewód lampy ulegnie uszkodzeniu, w celu uniknięcia zagrożenia jego wymiany może dokonać jedynie producent, jego przedstawiciel serwisowy lub inna wykwalifikowana osoba.

Do różnego rodzaju ścian pasują różne rodzaje wkretów. Wybieraj zawsze wkręty odpowiednie do Twoich ścian.

EESTI

Kui selle valgusti väline kaabel või juhe on kahjustatud, vahetab selle erilise juhtme vastu ainult tootja või tema esindaja, selleks, et vältida ohtlike olukordi.

Erinevatel seinte materjalidel kasutatakse erinevaid kruvisid. Valige ja kasutage alati kruvisid, mis sobivad spetsiaalselt teie seintele.

LATVIEŠU

Lai izvairītos no riska, šīs lampas vadu/ kabeļu bojājumus drīkst novērst tikai ražotājs, servisa pārstāvis vai cita kvalificēta persona.

Skrūves jāizvēlas atkarībā no sienu materiāla. Vienmēr izvēlieties skrūves, kas ir piemērotas konkrētajam sienu materiālam.

LIETUVIŲ

Jei lankstus kabelis ar laidas pažeistas, jį turi pakeisti gamintojas, jo techninio aptarnavimo atstovas ar kvalifikuotas specialistas.

Skirtingoms sienų apdailos medžiagoms reikalingos skirtingų tipų tvirtinimo priemonės. Visada pasirinkite tinkamas tvirtinimo priemones.

PORTUGUÊS

Se o cabo exterior flexível deste candeeiro se danificar, deverá ser

substituído exclusivamente pelo fabricante ou seu representante ou por uma pessoa qualificada, para evitar acidentes.

Os diferentes materiais de parede requerem diferentes tipos de parafusos. Escolha sempre parafusos adequados aos materiais das suas paredes.

ROMÂNĂ

În cazul în care cablul electric al acestui corp de iluminat este deteriorat, va fi înlocuit numai de către producător sau de agentul de servicii al acestuia, sau de către o altă persoană specializată, pentru a evita accidentările.

Materialele variate din care sunt construiți pereții necesită diferite tipuri de șuruburi. Alege întotdeauna șuruburi adecvate materialelor pereților tăi.

SLOVENSKY

V prípade, ak sa vonkajší zdrojový kábel svietidla poškodí, je nutné, aby ho vymenil výrobca alebo jeho servisný zástupca, prípadne kvalifikovaný elektrikár tak, aby nedošlo k ohrozeniu zdravia. Rôzne typy stien vyžadujú rôzne typy skrutiek. Vždy použite skrutky vhodné do daného materiálu.

SLOVENŠČINA

Če je zunanji kabel ali žica svetila poškodovan/a, naj zamenjavo opravi proizvajalec, njegov pooblaščenj serviser ali podobno usposobljena oseba. S tem se izognete nepotrebnim tveganjem.

Različni stenski materiali zahtevajo različne vrste vijakov. Vedno uporabite takšne vijake, ki ustrezajo sestavi vaše stene.

SRPSKI

Ako je spoljni savitljivi kabl ili vod ove lampe oštećen, u cilju izbegavanja rizika, treba da ga zameni isključivo proizvođač, ovlašćeni serviser ili stručna osoba.

Različite vrste zidova zahtevaju različite tiplove. Uvek odaberite tiplove koji odgovaraju vrsti vašeg zida.

SUOMI

Jos valaisimen uloin, taipuisa kaapeli tai johto vioittuu, turvallisuussyistä sen saa vaihtaa vain valmistaja tai valtuutettu huoltoliike.

Erilaisiin seinämateriaaleihin on käytettävä erilaisia ruuveja. Valitse kotisi seinämateriaaliin sopivat ruuvit.

РУССКИЙ

Если наружный гибкий удлинитель или шнур этого светильника поврежден, то во избежание

несчастного случая его должен заменить либо сам производитель, либо представитель сервисной службы производителя, либо человек соответствующей квалификации.

Для различного типа стен требуются различные виды шурупов. Всегда выбирайте шурупы, которые подходят к материалу Ваших стен.

BAHASA INDONESIA

Jika bagian luar kabel fleksibel atau kabel sambungan untuk penerangan ini rusak, maka harus digantikan oleh pabrik pembuat atau agen pelayanannya atau orang yang berkualifikasi agar terhindari dari bahaya.

Untuk bahan dinding yang berbeda membutuhkan jenis sekrup yang berbeda. Selalu memilih sekrup yang sesuai untuk bahan dinding Anda.

BAHASA MALAYSIA

Jika kabel atau kord fleksibel luaran bagi lampu ini telah rosak, ia patut diganti secara eksklusif oleh pengeluar atau ejen perkhidmatannya atau individu yang berkelayakan agar bahaya dapat dielakkan.

Bahan dinding yang berlainan memerlukan jenis skru yang berlainan. Sentiasa pilih skru yang paling sesuai dengan bahan binaan bagi dinding anda.

HRVATSKI

Ako je strujni kabel oštećen, mora ga zamijeniti isključivo proizvođač ili njegov ovlaštenu servisera ili slična kvalificirana osoba kako bi se izbjegla opasnost.

Različite vrste vijaka koriste se za različite vrste zidova. Uvijek odaberite vijake koji točno odgovaraju vrsti vaših zidova.

繁中

如果燈具的外部電線受損，應由製造商、服務人員或相關的專業人員替換，以避免發生危險。

請選購適合貴戶牆壁材質的螺絲配件

中文

如果这种照明装置的外部软电缆或电线受到损坏，必须由制造商、其代理商或具有相近资质的人员进行更换，防止发生伤害事故。

不同的安装面材需采用不同类型的安装螺钉。根据墙体材料，选择适用的安装五金件。

한국어

본 조명기구의 가요성 외부 케이블이나 코드가 손상되었을 경우 위험한 사고를 방지하기 위해 반드시 제조사, 지정 서비스 업체, 또는 전문가에 의뢰 교체되어야 합니다.

벽에 따라 다른 종류의 나사를 사용해야

합니다. 반드시 벽에 적합한 나사를
사용하세요.

日本語

この照明器具の外部ケーブルやコード
が破損した場合は、修理に伴う事故
を避けるため、必ず製造元のメーカ
ーや代理店、電気工事店などに部
品交換を依頼してください。

器具を固定するためのネジは壁の材質
により異なります。必ず壁の材質に合
ったネジを使用してください。

ASSEMBLY GUIDE

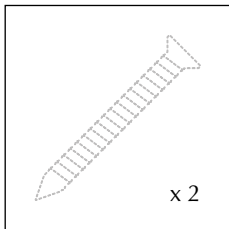

Ⓐ x 1 pc.

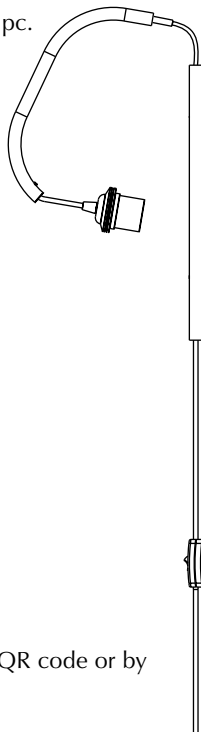

Ⓑ x 1 pc.



Ⓒ x 2 pcs.



Find assembly videos by using the QR code or by going online at our website
umage.com/instructions

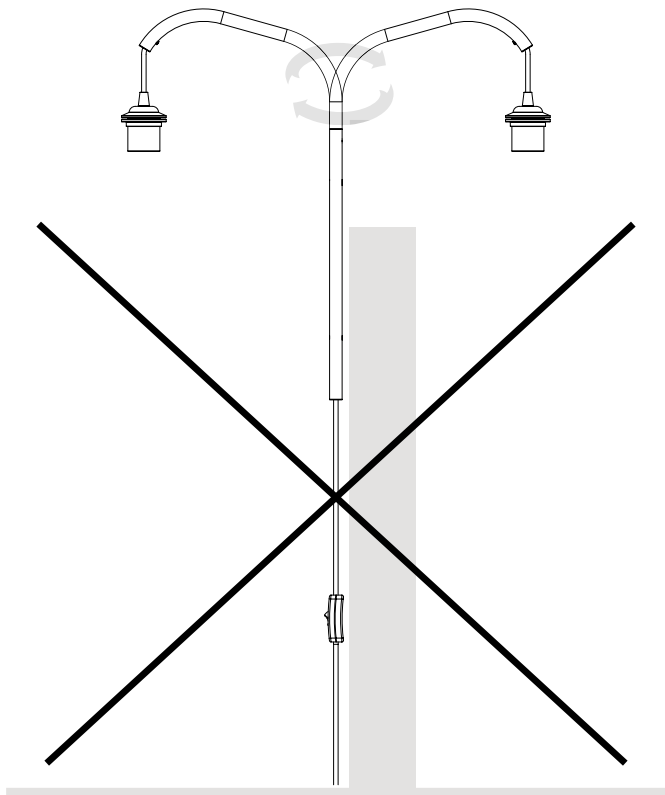

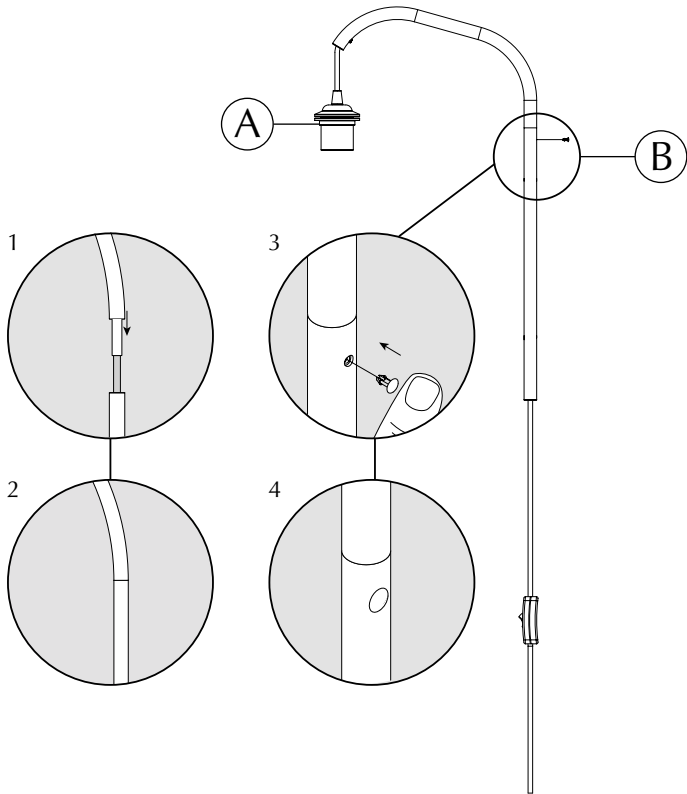

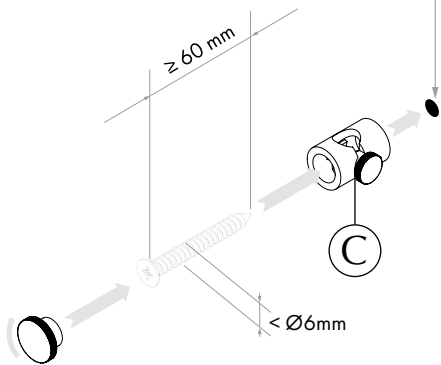
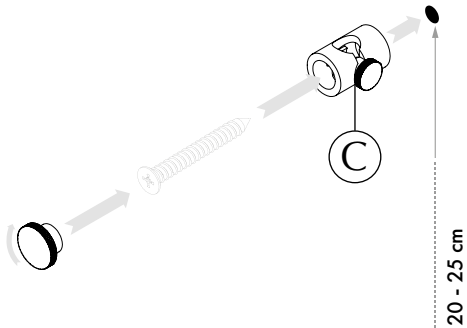
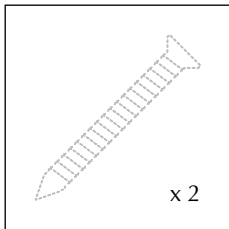

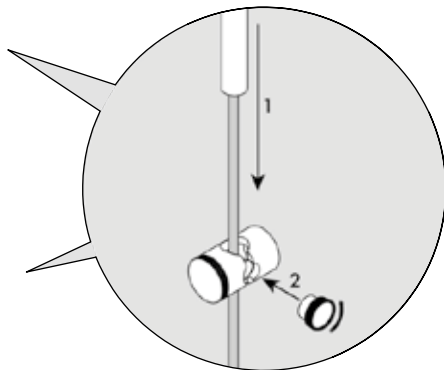
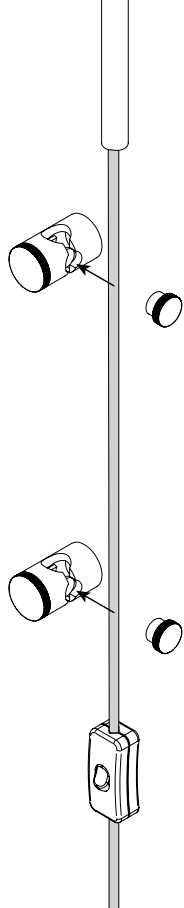

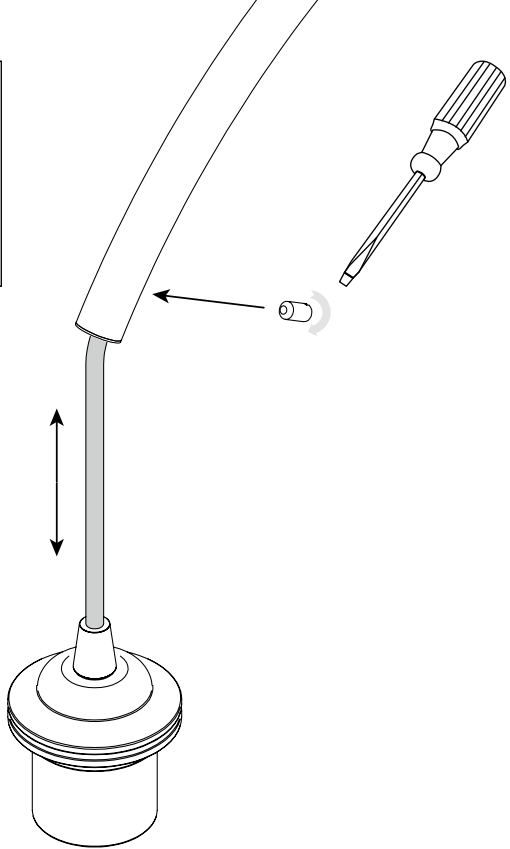
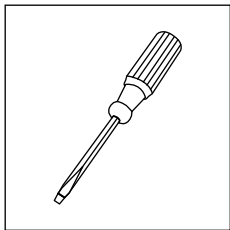

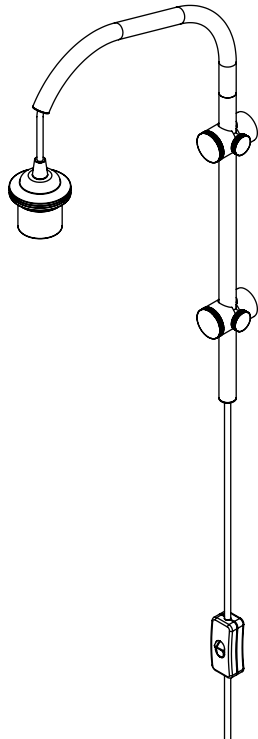

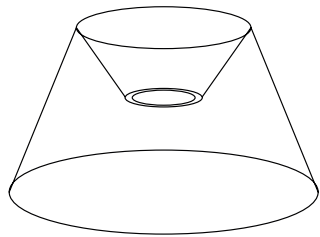
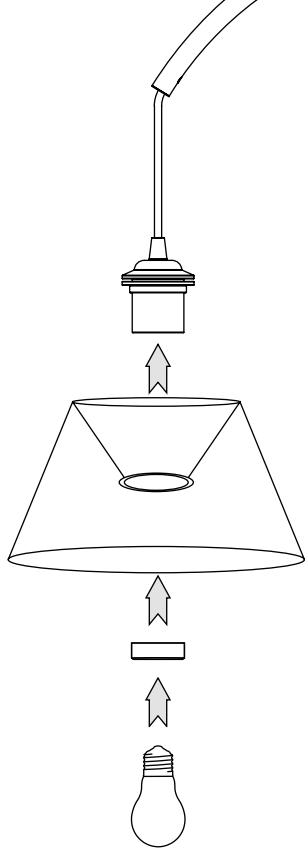

— MAX 40 CM / 2 KG —



DESIGNED BY
SOREN RAVN CHRISTENSEN

“ Practical cosiness, at its best! Place Willow near the bed, behind the couch, in a corner or anywhere you need to add extra light. „

UNFOLD AND FOLLOW THE INSTRUCTIONS

MAINTENANCE

- **Always turn electrical power off before cleaning the product or changing the bulb.**
- **Cleaning should be done with dry cloth. Avoid using any form of moisture, solvents and chemicals, when cleaning the product.**
- **NEVER touch the light bulb immediately after the light has been turned off. Beware of possible scalding! Let the light bulb cool off sufficiently before changing the bulb.**
- **Avoid tension on the textile cord while handling the product.**

UNFOLD AND FOLLOW THE INSTRUCTIONS

SUITABLE LAMP SHADES

- **The diameter of the lamp shade should NOT exceed 15.75in (400mm).**
- **The lamp shade should have openings in both top and bottom to facilitate heat dispersion.**
- **The minimum diameter of open area (top and bottom) should NOT be less than 100mm (4 inches); Lamp-to-shade spacing must be over 3-1/4 inches (63.5mm); Lamp Centerline Length must be over 2-1/2 inches (82.5mm).**
- **The weight of the lamp shade should NOT exceed 1.1KGS (2-1/2LBS)**

WARNING

Ignoring any of the Safety Instructions, or deviating from any of the steps in either the Installation-, the Maintenance- or the Suitable Lamp Shade section may result in a risk of fire or electric shock. You are advised to contact a qualified electrician for these procedures.

SAFETY PROCEDURES

Read and keep these instructions for future reference

- This product is NOT a children's toy and should NOT be used in any other manner than described throughout this user guide.**
- This product is for indoor use ONLY excluding any wet areas.**

- **Do NOT install this product near flammables or near heat sensitive objects.**
- **Do NOT try to repair the product if any of the electrical or mechanical components are in any way broken, not as expected or malfunctioning. Contact UIMAGE or a qualified electrician.**
- **Different wall materials require different types of screws. Always choose screws that are specially suited to the materials of your walls.**

CUNA
matt white



UMAGE UNFOLD AT HOME

GET THE FREE UIMAGE APP

Preview our entire collection in your own home – before you buy

Imagine an UIMAGE lamp or furniture piece in your home. Is it the right design, size and colour? We made it easier for you to find the perfect UIMAGE design. Just download our free **UMAGE Unfold at Home** app from the App Store or Play Store, and see how our designs will look in your home!



FOLLOW US ON SOCIAL MEDIA



@umagedesign | #umagedesign | umage.com



UMAGE